

DO NOT REMOVE

Briggs & Stratton

OPERATING AND MAINTENANCE INSTRUCTIONS MODELS

401400 to 402499 421400 to 422499

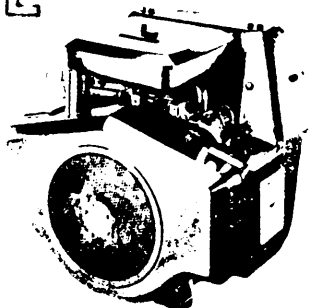

IN THE INTEREST OF SAFETY

DO NOT RUN ENGINE AT EXCESSIVE SPEEDS. Operating an engine at excessive speeds increases the hazard of personal injury. DO NOT TAMPER WITH PARTS WHICH MAY INCREASE THE GOVERNED SPEED.

For rotary lawnmower safety, A.N.S.I. Standard Safety Specifications for Power Lawn Mowers specify a maximum blade tip speed of 19,000 feet per minute (96.5 meters per second), primarily to reduce the hazard from thrown objects.

Rotary lawnmower manufacturers select the governed top speed of the engine based on the length and design of the cutter blade and design of other mower parts.

All rotary lawnmowers should be checked for conformance to the A.N.S.I. Standard Safety Specifications for Power Lawn Mowers on blade tip speed, if the engine is repaired or replaced, or if mower parts are changed.

DANGER: GASOLINE VAPOR IS HIGHLY FLAMMABLE. Refuel outdoors preferably, or only in well ventilated areas.

DO NOT STORE, SPILL OR USE GASOLINE NEAR AN OPEN FLAME or devices such as a stove, furnace, water heater which utilize a pilot light, or devices that can create a spark.

If gasoline is accidentally spilled, move machine away from area of spill and avoid creating any source of ignition until gasoline vapors have dissipated.

DO NOT REFUEL GASOLINE TANK WHILE ENGINE IS RUNNING.

DO NOT RUN THE ENGINE IN AN ENCLOSED AREA. Exhaust gases contain carbon monoxide, an odorless and deadly poison.

TO PREVENT ACCIDENTAL STARTING always remove the spark plugs from the engine, before working on the engine or equipment driven by the engine.

Except for adjustment; DO NOT operate engine if air cleaner or cover directly over carburetor air intake is removed. Removal of such part could create a fire hazard.

DO NOT OPERATE WITHOUT A MUFFLER OR TAMPER WITH THE EXHAUST SYSTEM. Damaged mufflers or spark arresters could create a fire hazard. Inspect periodically and replace if necessary.

DO NOT STRIKE FLYWHEEL with a hard object or metal tool as this may cause flywheel to shatter in operation, causing personal injury or property damage. Use Briggs & Stratton approved tools only, and if in doubt, contact your Authorized Briggs & Stratton Service Center.

ALWAYS KEEP HANDS AND FEET CLEAR OF ROTATING PARTS.

IN THE INTEREST OF ENVIRONMENT

A muffler which leaks because of rust or damage can permit an increased exhaust noise level. Therefore, examine the muffler periodically to be sure it is functioning effectively. To purchase a new muffler, see SERVICE AND REPAIR INFORMATION.

WARNING: If this engine is not equipped with a spark arrester and is to be used on any forest covered, brush covered, or grass covered unimproved land, before using on such land a spark arrester must be added to the muffler. The arrester must be maintained in effective working order by the operator. In the State of California the above is required by law (Section 4442 of the California Public Resources Code). Other states may have similar laws. Federal laws apply on federal lands. See your Authorized Briggs & Stratton Service Center for spark arrester muffler options.

SERVICE & REPAIR INFORMATION

If service or repair is needed, contact an Authorized Briggs & Stratton Service Center. To serve you promptly and efficiently, the Service Center will need the model, type and code number on your engine.

Each Authorized Service Center carries a stock of original Briggs & Stratton repair parts and is equipped with special service tools. Trained mechanics assure expert repair service on all Briggs & Stratton engines.

Major engine repairs should not be attempted unless you have the proper tools and a thorough knowledge of internal combustion engine repair procedure.



Your nearest service center is listed in the "Yellow Pages" under "Engines, Gasoline" or "Gasoline Engines." He is one of over 25,000 authorized dealers available to serve you.

This illustrated book includes common specifications, and detailed information covering the adjustment, tune-up and repair procedures for Twin Cylinder models. It is available from any Authorized Briggs & Stratton Service Center. Order as Part Number 271172.

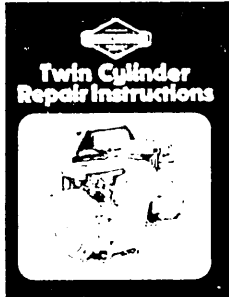

BRIGGS & STRATTON CORP.
Milwaukee, Wisconsin 53201

IMPORTANT SAFETY INFORMATION AND INSTRUCTIONS FOR ENGINE SELECTION ENGINE INSTALLATION ENGINE OPERATION

In the USA and Canada,
our 24 hour hotline is:

18002333723

Briggs & Stratton Corporation
Milwaukee, Wisconsin 53201

www.briggsandstratton.com

Keep these instructions for future reference.





Before installing and operating this engine read and observe all warnings, cautions and instructions on both sides of this sheet, on the engine, and in the operating & maintenance instructions.

NOTE: This sheet of instructions and safety information is not meant to cover all possible conditions and situations that may occur. Read entire Operating & Maintenance Instructions for this engine AND the instructions for the equipment this engine powers. Failure to follow instructions and safety information could result in serious injury or death.

The safety alert symbol () is used to identify safety information about hazards that can result in personal injury.

A signal word (DANGER, WARNING, or CAUTION) is used with the alert symbol to indicate the likelihood and the potential severity of injury. In addition, a hazard symbol may be used to represent the type of hazard.

 **DANGER** indicates a hazard which, if not avoided, will result in death or serious injury.

 **WARNING** indicates a hazard which, if not avoided, could result in death or serious injury.

 **CAUTION** indicates a hazard which, if not avoided, might result in minor or moderate injury.

CAUTION, when used **without** the alert symbol, indicates a situation that **could result in damage to the engine.**

HAZARD SYMBOLS AND MEANINGS



Fire



Explosion



Moving Parts



Toxic Fumes



Hot Surface



Shock



Kickback

(OVER)

FORM MS-6445-01/03

ENGINE SELECTION



 WARNING



Failure to select the correct engine could result in fire or explosion.



- Some engines are unique and designed for specific applications or types of equipment. If this engine will be used to build new equipment, contact Briggs & Stratton to ensure that the engine is appropriate for the intended use.
Note: For all Go-karts use only a model 136200 series engine, which offers improved safety and performance.
- Replacement engines should be the same model as the original engine, or be the Briggs & Stratton designated replacement engine. Refer to the Operation & Maintenance Instructions for engine identification information.
Note: For all Go-karts use only a model 136200 series engine, which offers improved safety and performance.
- Do not use Briggs & Stratton engines on 3-wheel All-Terrain Vehicles (ATVs), motor bikes, air craft products, or vehicles intended for use in competitive events. Briggs & Stratton does not approve of or authorize such uses.

ENGINE INSTALLATION



- [1] Do not attempt to install this engine if you do not have the appropriate tools and knowledge of small engine installation procedures. Use only Briggs & Stratton parts. Contact your Authorized Service Dealer for assistance.
- [2] Do not modify the engine in any way without Briggs & Stratton factory approval. Any such modification is at the owner's sole risk.
- [3] If the exhaust system on the old engine was supplied by the equipment manufacturer, you must transfer the exhaust system and related components (original muffler and related pipes, brackets, clamps, and shields) to the new engine. All components must be in good condition.
- [4]



 WARNING	Install muffler (and muffler deflector if used) so outlet points away from operator, fuel tank, and equipment, and so muffler heat will not damage or deform engine and components.
	
- [5]



 WARNING	Ensure all fuel lines and fittings are properly assembled and do not leak. Replacement parts must be the same model as the original.
	
- [6]



 WARNING	Ensure all wiring, including safety switches and engine shut-off components are completely installed and functioning properly.
	
- [7] Set engine speed to equipment manufacturer's specification. Refer to equipment manufacturer's manual. Do not tamper with governor springs, or other parts that will increase engine speed above specification.

- [8]



 WARNING	All engine parts, including fuel cap, spark plug, muffler, air cleaner, and covers and guards for drive components (gears, belts, shafts, couplings, etc.) must be in place before attempting to start engine.
	
- [9]



 WARNING	If engine is installed on walk behind lawn mower, all mower components, including cutting blade, must be correctly installed before attempting to start engine.
	
- [10]



 WARNING	When working on the engine or equipment, remove spark plug wire from spark plug. For electric start, remove negative wire from battery.
	
- [11]

 WARNING	Do not check for spark with spark plug removed. Use Briggs & Stratton spark tester #19368.
	

ENGINE OPERATION

	 WARNING
When adding fuel:	
Turn engine off and let engine cool at least 2 minutes before removing gas cap. Fill fuel tank outdoors or in well-ventilated area. Fill tank to about 1 inch below lowest portion of neck to allow for fuel expansion. Keep gasoline away from sparks, open flames, pilot lights, heat, and other ignition sources.	

	 WARNING
When starting engine:	
Remove all external equipment/engine loads. Wait until spilled fuel is evaporated. Start engine outdoors. Pull cord slowly until resistance is felt, then pull rapidly. If engine floods, set choke to OPEN/RUN, place throttle in FAST and crank until engine starts.	

	 WARNING
When operating equipment:	
Do not tip engine or equipment at angle which causes gasoline to spill. Run engine outdoors. Do not run in enclosed area, even if doors or windows are open. Do not choke carburetor to stop engine.	

BEFORE STARTING

READ THE OPERATING INSTRUCTIONS OF THE EQUIPMENT THIS ENGINE POWERS

Use a high quality detergent oil classified "For Service SC, SD, SE or MS." Detergent oils keep the engine cleaner and retard the formation of gum and varnish deposits. Nothing should be added to the recommended oil.

RECOMMENDED SAE VISCOSITY GRADES

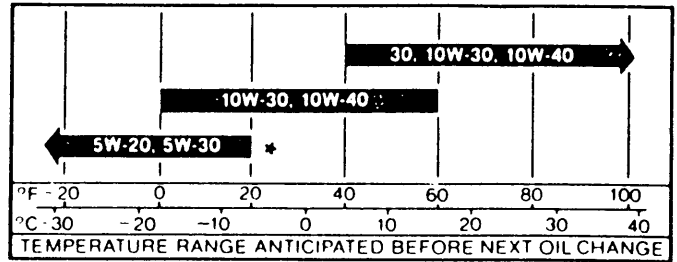

*If not available, a synthetic oil may be used having 5W-20, 5W-30 or 5W-40 viscosity.

FILL CRANKCASE WITH OIL

Place engine level. Clean area around oil fill before removing dipstick.

EXTENDED OIL FILL. Remove cap and dipstick. **FILL TO FULL MARK** on dipstick, **POUR SLOWLY**. Capacity 3 pints (1.42 liters). When checking oil level, push dipstick assembly firmly but slowly until cap bottom on tube. **DO NOT OVERFILL.** Dipstick assembly must be securely assembled into tube at all times when engine is operating.

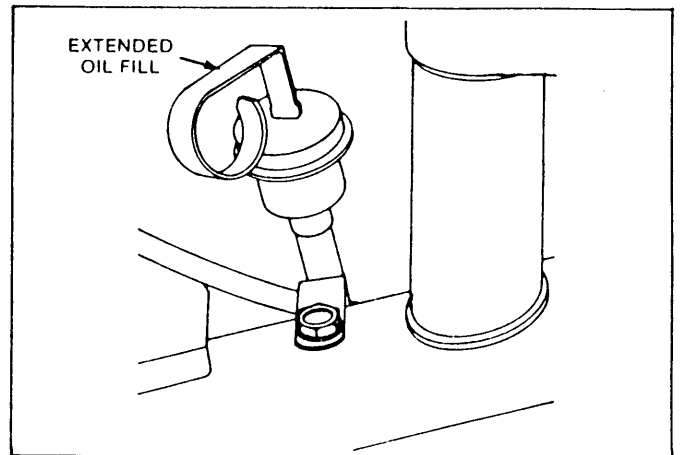

CHARGE BATTERY

Charge battery before use on engines equipped with (OPTIONAL) 12 volt electric starter motor. See equipment manufacturers' recommendations.

FILL FUEL TANK

Use clean, fresh, "regular grade leaded or low-lead" gasoline. **DO NOT MIX OIL WITH GASOLINE.**

NOTE: The use of "lead-free" gasoline produces fewer combustion deposits, but may shorten valve life if carburetor adjustment is too lean.

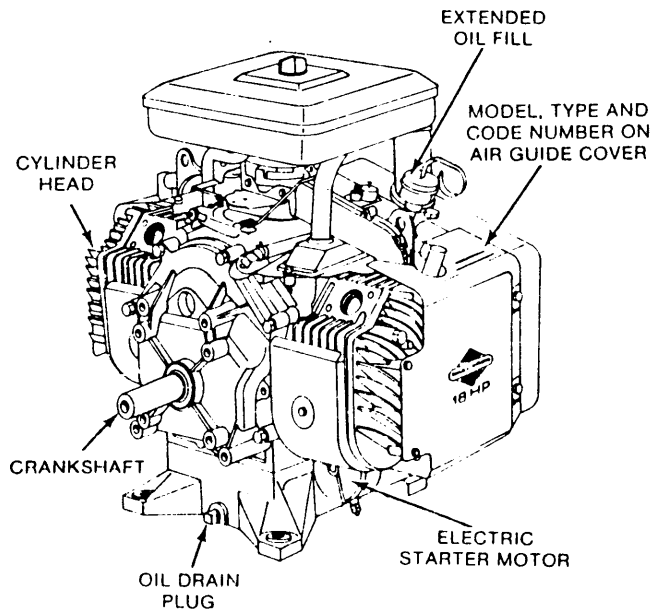
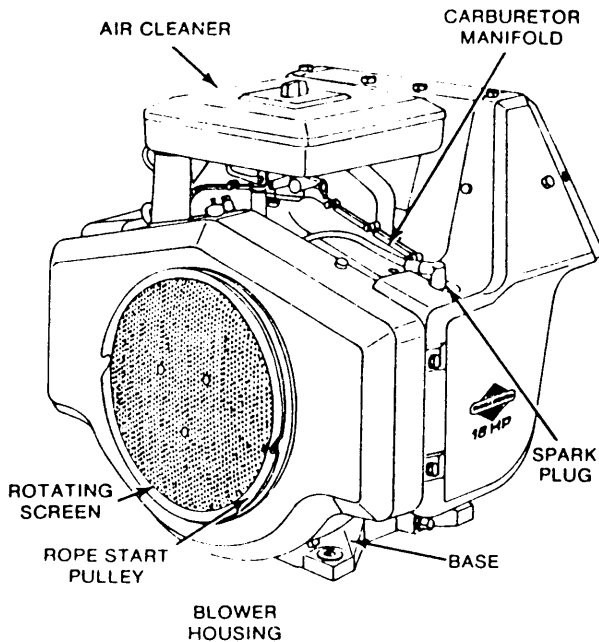

STARTING

OPEN FUEL VALVE on engines so equipped.

CHOKE ENGINE: Move equipment control lever to "CHOKE" position.

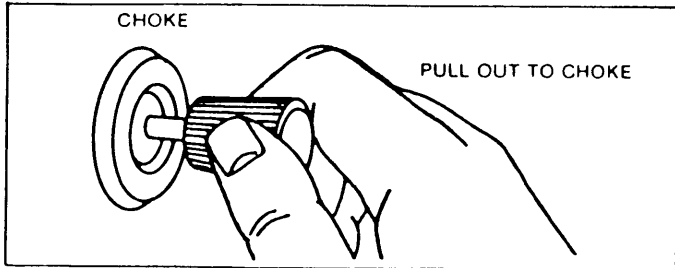

NOTE: This should fully close choke on carburetor. If it does not, remote control must be re-adjusted. See ADJUSTMENT section.

NOTE: A warm engine requires less choking than a cold engine.

GOVERNOR SPEED CONTROL LEVER: Move governor speed control lever to "RUN," "FAST" or "START" position if so equipped.

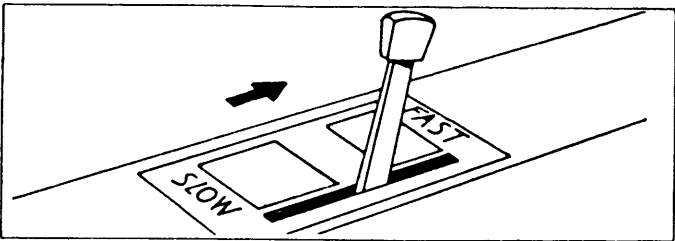

TO START ENGINE

DANGER: ALWAYS KEEP HANDS AND FEET CLEAR OF MOWER BLADE OR OTHER ROTATING MACHINERY.

Rope Starter. Wind the starter rope around the pulley in direction shown by arrow. Pull the rope with a quick full arm stroke to overcome compression and prevent kickback. Repeat if necessary with choke opened slightly. When engine starts open choke gradually.

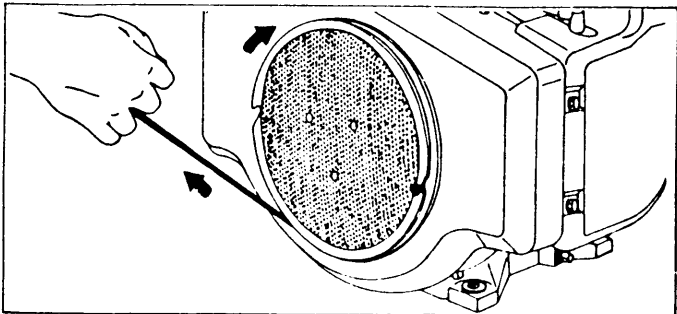

CAUTION: When using rope starter to crank engine, use caution so knotted end of rope does not strike persons standing nearby.

Electric Starter. Turn key to "Start" position and/or press starter button on powered equipment. When engine starts open choke gradually.

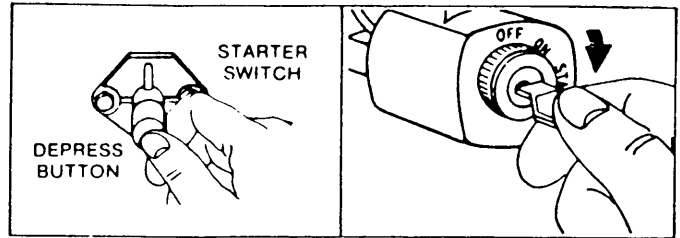

When equipment is not in operation, provide protection from direct exposure to weather.

COLD WEATHER STARTING HINTS

1. Be sure to use the proper oil for the temperature expected.
2. Declutch all possible external loads.
3. Set throttle at part-throttle position.
4. A slightly richer fuel mixture, obtained by turning carburetor needle valve 1/8 turn counterclockwise, will usually improve cold starting.
5. A warm battery has much more starting capacity than a cold battery.
6. Use fresh winter grade fuel.

NOTE: Winter grade gasoline has higher volatility to improve starting. Do not use gasoline left over from summer.

TO STOP ENGINE

Turn key to "OFF" position.

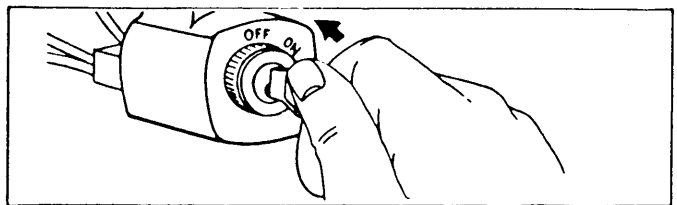

CAUTION: Always remove key from switch when leaving equipment unattended or when equipment is not in use.

MAINTENANCE

CHECK OIL LEVEL regularly — after each five hours of operation. **BE SURE OIL LEVEL IS MAINTAINED.**

CHANGE OIL after first five hours of operation. Thereafter change oil every 25 hours of operation. Remove oil drain plug and drain oil while engine is warm. Replace drain plug. Remove dipstick and refill with new oil of proper grade. Replace dipstick.

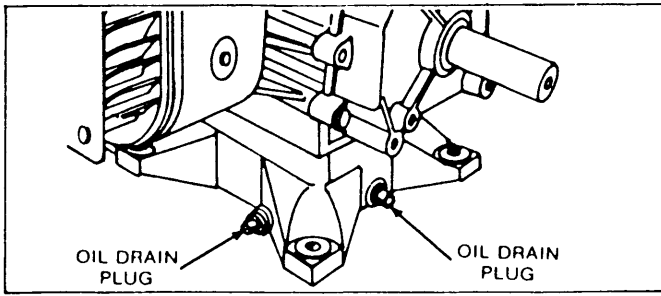

TO SERVICE DUAL ELEMENT AIR CLEANER

Clean and re-oil foam pre-cleaner at three month intervals or every 25 hours, whichever occurs first.

NOTE: Service air cleaner more often under dusty conditions.

1. Remove knob and cover.
2. Remove foam pre-cleaner by sliding it off the paper cartridge.
3.
 - a. Wash foam pre-cleaner in kerosene or liquid detergent and water.
 - b. Wrap foam pre-cleaner in cloth and squeeze dry.
 - c. Saturate foam pre-cleaner in engine oil. Squeeze to remove excess oil.
4. Install foam pre-cleaner over paper cartridge. Re-assemble cover and screw down tight.

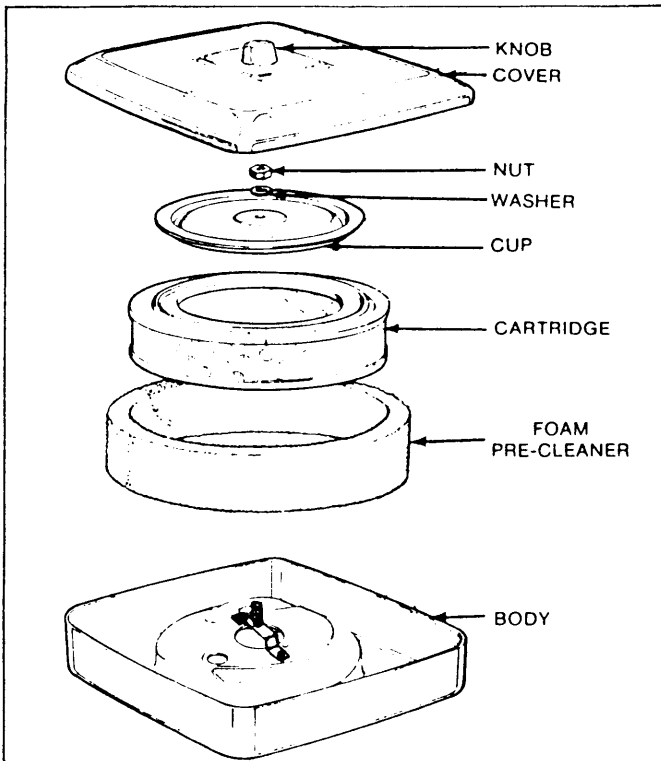

Yearly or every 100 hours, whichever occurs first, remove paper cartridge. Clean by tapping gently on flat surface. If very dirty, replace cartridge, or wash in a low or non-sudsing detergent and warm water solution. Rinse thoroughly with flowing water from inside out, until water is clear. Cartridge must be allowed to stand and air dry thoroughly before using. Service more often if necessary.

CAUTION: Petroleum solvents, such as kerosene, are not to be used to clean cartridge. They may cause deterioration of the cartridge. DO NOT OIL CARTRIDGE. DO NOT USE PRESSURIZED AIR TO CLEAN OR DRY CARTRIDGE.

CLEAN COOLING SYSTEM — Grass, chaff or dirt may clog the rotating screen and the air cooling system, especially after prolonged service in cutting tall dry grasses. Yearly or every 100 hours, whichever occurs first, remove the blower housing and clean the areas shown to avoid overspeeding, overheating and engine damage. Clean more often if necessary.

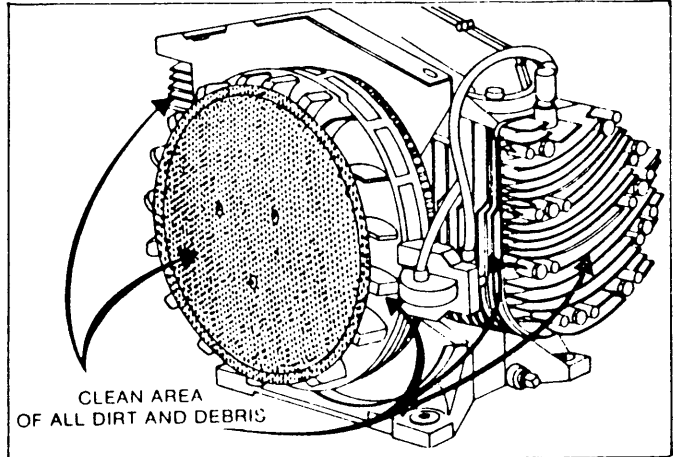

DANGER: Periodically clean muffler area to remove all grass, dirt and combustible debris.

SPARK PLUGS — Clean and reset gap at .030" every 100 hours of operation.

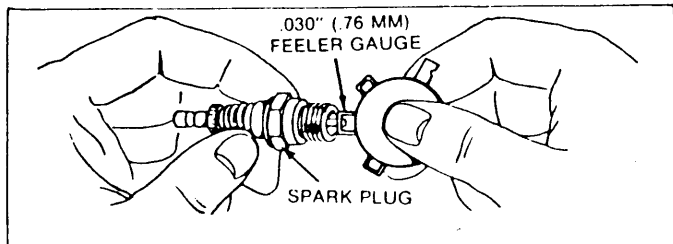

CAUTION: Do not blast clean spark plugs. Spark plug should be cleaned by scraping or wire brushing and washing with a commercial solvent.

Sparking can occur if wire terminals do not fit firmly on spark plugs. Reform terminals if necessary.

REMOVE COMBUSTION DEPOSITS every 100-300 hours of operation. Remove cylinder heads and cylinder head shields. Scrape and wire brush the combustion deposits from cylinder, cylinder heads, top of pistons and around valves. Use a soft brush to remove deposits. Re-assemble gaskets, cylinder heads and cylinder head shields. Turn screws down finger tight, with the three longer screws around the exhaust valve, if so equipped. Torque cylinder head screws in a staggered sequence to 165 inch pounds (18.65 Nm).

SPARK ARRESTER EQUIPPED MUFFLER — If engine muffler is equipped with spark arrester screen assembly, remove every 50 hours for cleaning and inspection.

4. Replace if damaged.

ADJUSTMENTS

CARBURETOR ADJUSTMENTS

Minor carburetor adjustment may be required to compensate for differences in fuel, temperature, altitude or load.

THE TWIN CYLINDER ENGINE CARBURETOR FUEL MIXTURE ADJUSTMENT PROCEDURE IS UNIQUE. ADJUST CARBURETOR FUEL MIXTURE IN THE ORDER STATED AS FOLLOWS.

Turn the high speed mixture valve clockwise until it just closes. CAUTION: Valves may be damaged by turning them in too far. Open needle valve 1-1/2 turns counterclockwise. Close the idle mixture valve in the same manner, and open it 1-1/2 turns. This initial adjustment will permit the engine to be started, and warmed up prior to final adjustment.

NOTE: All carburetor adjustments must be made with air cleaner on engine.

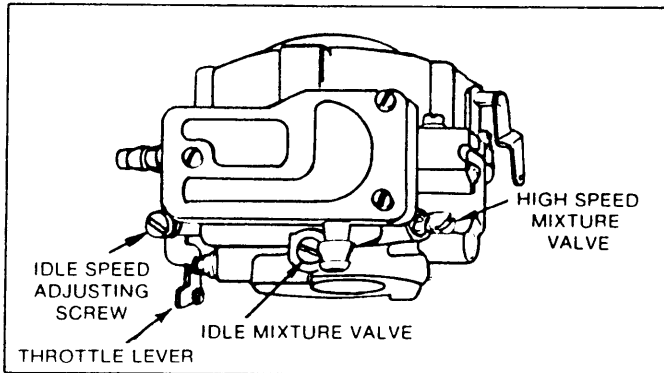

Start engine and place equipment speed control lever in idle position. Hold carburetor throttle lever against idle stop, and adjust idle speed screw to obtain approximately 1400 RPM. Turn idle mixture valve slowly clockwise (lean mixture) until engine misses or speed drops. Then turn idle mixture valve 1/2 turn counterclockwise. Place equipment speed control lever in fast position. Turn high speed mixture valve slowly clockwise (lean mixture) until engine misses or speed drops. Then turn high speed mixture valve 1/2 turn counterclockwise.

If the engine does not accelerate properly, re-adjust high speed mixture valve approximately 1/8 turn counterclockwise (rich).

CONTROL ADJUSTMENTS

Proper choke and speed control operation is dependent upon proper adjustment of remote controls on the powered equipment.

TO CHECK OPERATION OF CHOKE CONTROLS:

Move remote control lever to "choke" position. The carburetor choke should be closed.

TO ADJUST CHOKE:

Place remote control lever on equipment in "CHOKE" position. Loosen control casing clamp screw. Move control casing and wire until choke is completely closed. Tighten casing clamp screw.

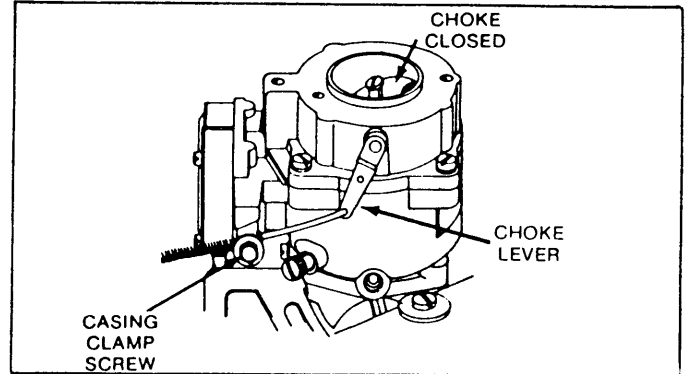

GOVERNOR SPEED CONTROL ADJUSTMENT

The acceptable operating speed range is 1800 to 3600 RPM. Idle speed is 1400 RPM. The manufacturer of the equipment on which the engine is used, specifies the top governed no load speed at which the engine may be operated. DO NOT EXCEED this speed.

Engine speed is controlled by movement of the control lever. Move control lever on equipment, "A", to slowest engine speed possible. Throttle lever on carburetor should touch idle speed adjusting screw. To adjust, loosen control casing clamp screw "B." Move control casing and wire in direction shown by arrow until throttle lever touches idle speed adjusting screw on carburetor. Retighten casing clamp screw "B."

CAUTION: Throttle lever on carburetor MUST touch idle speed adjusting screw when equipment control lever is in slowest position.

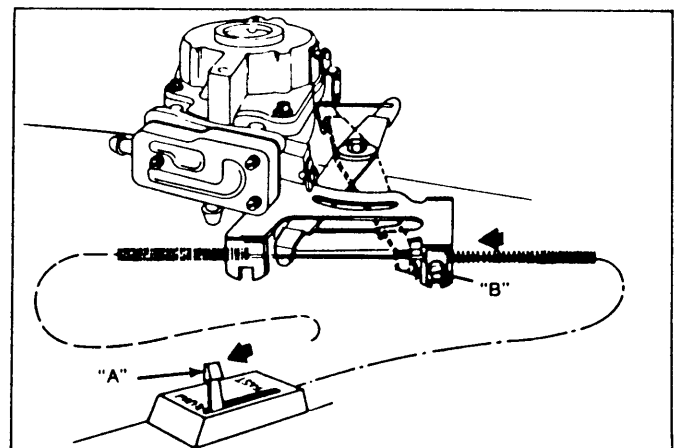

GENERAL INFORMATION

These engines are two-cylinder L-head, air-cooled type.

MODEL SERIES 401400 to 402499

Bore 3-7/16" (87.31 mm)
 Stroke 2-5/32" (54.77 mm)
 Displacement 40.00 cu. in. (656.0 cc)
 Horsepower 16 HP Max. @ 3600 RPM
 Torque (Ft.-Lbs.) 25.8 Max. @ 2700 RPM

MODEL SERIES 421400 to 422499

Bore 3-7/16" (87.31 mm)
 Stroke 2-9/32" (57.94 mm)
 Displacement 42.33 cu. in. (694.0 cc)
 Horsepower 18 HP @ 3600 RPM
 Torque (Ft.-Lbs.) 28.6 @ 2600 RPM

The horsepower ratings listed above are established in accordance with the Society of Automotive Engineers Test Code-J607. For practical operation, the horsepower loading should not exceed 85% of this rating. Engine power will decrease 3½% for each 1,000 feet (304.8 m) above sea level and 1% for each 10° above 60° F (16° C).

In some areas, local law requires the use of a resistor spark plug so as to suppress ignition signals. If an engine was originally equipped with resistor spark plugs, be sure to use the same type of spark plugs for replacement.

TUNE-UP SPECIFICATIONS

Spark Plug Type	Champion	AC	Autolite
Resistor Long Plug	RJ-12	R-46	308

Spark Plug Gap030" (.76 mm)
 Ignition Point Gap020" (.51 mm)
 Intake Valve Clearance**004"-.006" (.10-.15 mm)
 Exhaust Valve Clearance**007"-.009" (.18-.23 mm)

**with valve spring installed.

WARNING: For electrical safety always remove cable from negative (-) side of the battery before attempting any repairs or maintenance.

TYPICAL WIRING DIAGRAMS

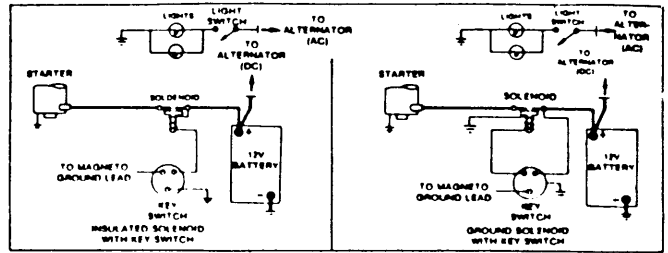
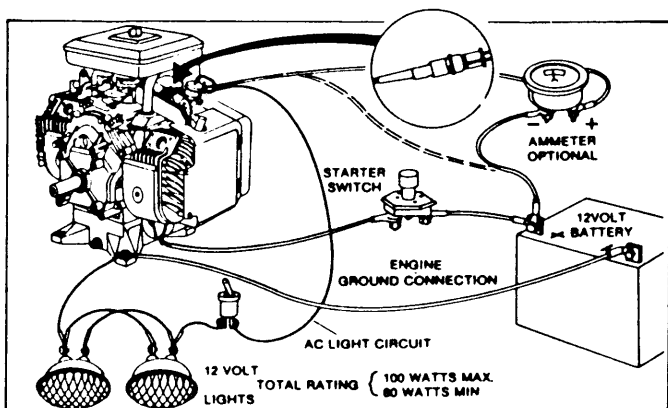

Dual Circuit

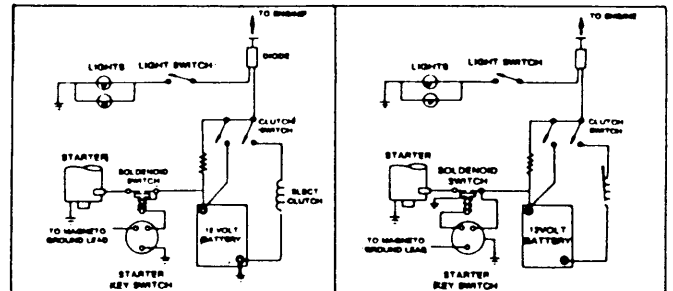

Tri-Circuit

STORAGE INSTRUCTIONS

Engines to be stored over 30 days should be completely drained of fuel to prevent gum deposits forming on essential carburetor parts, fuel filter and tank.

NOTE: The use of a fuel additive, such as STA-BIL, or an equivalent, will minimize the formation of fuel gum deposits during storage. Such an additive may be added to the gasoline in the fuel tank of the engine, or to the gasoline in a storage container.

- All fuel should be removed from the tank. Run the engine until it stops from lack of fuel. The small amount of fuel that remains in the sump of the tank should be removed by absorbing it with a clean, dry cloth.
- While engine is still warm, drain oil from crankcase. Refill with fresh oil.
- Remove spark plugs, pour one ounce (29.6 cc) of engine oil into each cylinder and crank slowly to distribute oil. Replace spark plugs.
- Clean dirt and chaff from cylinders, cylinder head fins, blower housing, rotating screen and muffler areas.
- Store in a clean and dry area.

BRIGGS & STRATTON ENGINES ARE MADE UNDER ONE OR MORE OF THE FOLLOWING PATENTS:

28,960	3,149,618	3,276,439	3,526,146	3,625,071	3,831,268	3,968,854
2,999,491	3,194,224	3,305,223	3,572,218	3,650,354	3,882,336	3,971,353
2,999,562	3,236,937	3,457,804	3,572,307	3,745,393	3,901,199	3,991,152
3,114,851	3,242,741	3,465,740	3,625,492	3,738,345	3,961,724	4,168,288
3,118,433	3,252,449					

DESIGN
 D-213,476 D-215,769 D-224,170 D-247,177
 OTHER PATENTS PENDING